



## Safety caution

### Warning

- All work related to the installation of this appliance must be performed by qualified service personnel or system installers.
  - If the product is connected or installed improperly, electric shock, fire, severe injury, and/or damage can result.
- Please install the product on a completely flat floor.
  - Always check the strength and stability of the installation location.
  - Do not drop the appliance on the floor. This may result in damage or injury. Do not attempt to disassemble the appliance. To prevent electric shock, do not remove screws or covers.
  - There are no user-serviceable parts inside. Contact qualified service personnel for maintenance.
- Never use the appliance in places where there are flammable materials.
  - Never use the appliance in places where flammable materials such as gas are used.
- This may result in fire, explosion, and other serious accidents.
- Never touch un-insulated parts with wet hands.
  - Touching un-insulated parts with wet hands may result in serious electric shock.
- Never expose the appliance to water or moisture.
  - If the appliance gets wet, immediately turn the power off.
  - Stop using the appliance if it gets wet. Contact the manufacturer immediately.
- Stop using the appliance if there appears to be any operational problem.
  - Immediately turn the power off to the appliance if there is any abnormal condition such as smoke or unusual smells.
  - Continuing to use the appliance under abnormal conditions may result in serious damage.
- Always use the recommended power.
  - Using incorrect power source ratings may result in fire, electric shock, or damage.
- Always handle the connection cable with care.
  - Never damage or modify the connection cable.
  - Do not pull, expose to heat, or place heavy objects on the connection cable.
  - Non-observance of these warnings may result in fire, electric shock or damage.

### Caution

- Use the appliance indoors only.
  - Do not place the appliance outdoors or expose it to rain or moisture.
  - If dropped in water, the appliance may be corroded and damaged.
- Do not use the appliance where there is excessive dust, smoke, or moisture.
  - Using the appliance under such conditions may result in fire, electric shock or serious damage.
- Do not operate the appliance in temperatures beyond those specified.
  - Excessive heat or cold may damage the appliance.
  - Always operate the appliance within the recommended temperature range of 0°C ~ 40°C.
- Do not place the appliance in direct sunlight.
  - This may discolor the appliance.
- Do not apply excessive shock to the appliance.
  - Excessive shock may damage the appliance.

### Maintenance and Repair

If the controller body gets dirty, turn the power off and wipe the surface with a soft cloth.  
- Do not use chemical agents such as alcohol or benzene. For detailed information on upgrading the firmware, please direct your inquiries to the installation vendor.

Refer all work related to the installation of this appliance to qualified service personnel or system installers.

#### For U.S.A

This equipment has been tested and found to comply with the limits for a Class A digital device, pursuant to Part 15 of the FCC Rules. These limits are designed to provide reasonable protection against harmful interference when the equipment is operated in a commercial environment. This equipment generates, uses, and can radiate radio frequency energy and, if not installed and used in accordance with the instruction manual, may cause harmful interference to radio communications. Operation of this equipment in a residential area is likely to cause harmful interference, in which case the user will be required to correct the interference at his own expense.

Avoid locations near power lines or where high frequency is used.  
Placing the product near electromagnetic wave generating communication equipments or transmission lines may cause the product to malfunction.

# Contents



<b>Safety caution</b> .....	2
<b>Features &amp; Distinctions</b> .....	6
■ Features .....	
<b>System Diagram</b> .....	7
1. System Connection Diagram .....	7
1-1. Front .....	7
1-2. Back .....	8
2. Basic Connection Diagram .....	9
2-1. Matrix System .....	9
2-2. Matrix Cable .....	10
2-3. Extension Matrix .....	10
2-4. Setting the SMX-25632 DIP Switch .....	11
<b>Matrix Settings</b> .....	12
1. Selection of camera and monitor .....	12
2. Joystick for Camera Controls .....	12

3. AUTO SELECT .....	12
3-1. AUTO SELECT Setup .....	12
3-2. AUTO SELECT Cancellation .....	13
3-3. AUTO SELECT Elimination .....	13
3-4. AUTO SELECT RUN/HOLD FUNCTION .....	13
4. ID SET .....	14
4-1. ID SET Setup .....	14
4-2. ID SET ON/OFF Setup1 .....	14
4-3. DISPLAY POSITION Setup .....	15
5. TIME/DATE SET .....	15
5-1. TIME/DATE Setup .....	15
5-2. ON/OFF Setup .....	16
5-3. DISPLAY POSITION Setup .....	16
<b>Check List</b> .....	17
<b>External View</b> .....	18
<b>MATRIX Features</b> .....	19

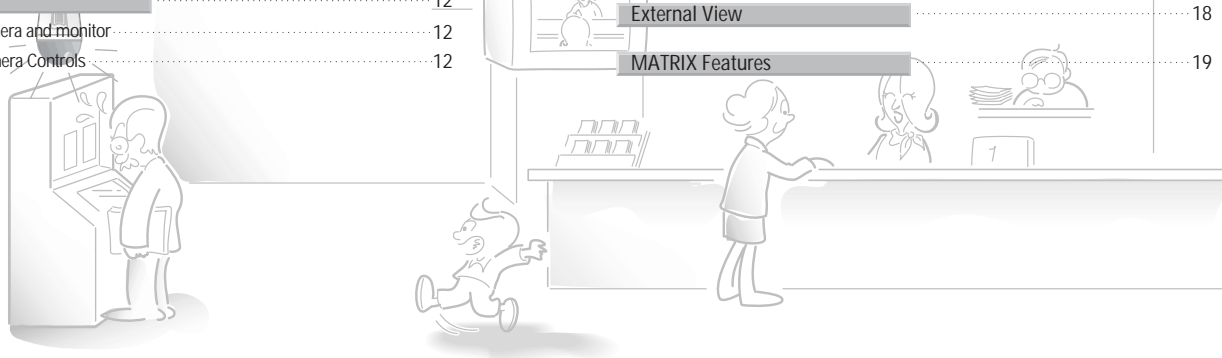

## Features

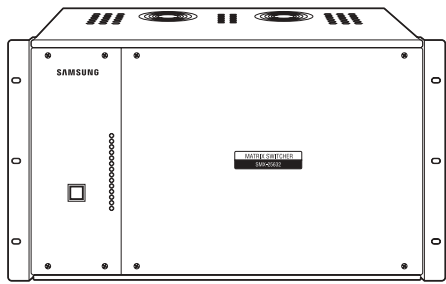

- ▶ **Input/Output**
  - 1 video card (SMV-25632) handles signals from 64 cameras & 2 monitors
  - Up to 16 video cards (SMV-25632) may be inserted into the main CPU (SMX-25632) to handle up to 32 monitors
- ▶ **OSD Output**
  - Supports 16 Korean characters or 32 alphabet letters
  - Built-in I/D, time, and generator function for each video card (SMV-25632)
  - Features prevention for screen-shakes caused by changes in sync signal when switching between manual and auto camera
- ▶ **CPU Extension**
  - Extension set (SME-25632) - 1 extension unit: controls 128 cameras & 32 monitors  
 2 extension unit: controls 192 cameras & 32 monitors  
 3 extension unit: controls 256 cameras & 32 monitors
- ▶ **System Distinctions**
  - Easy to insert/remove, manage, maintain, or extend video cards
- ▶ **Power Unit**
  - Built-in power unit for safer power supply

## 1. System Connection Diagram

### 1-1. Front

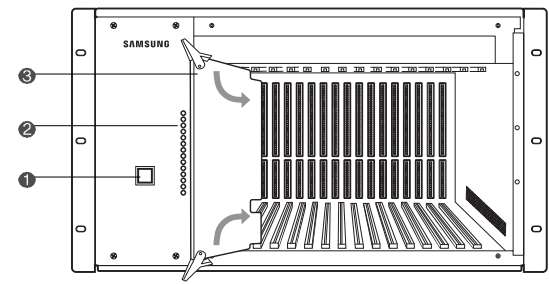

- ① **MAIN POWER**  
Turns the power of the device on/off
- ② **STATUS**  
Displays the operating status of the device
- ③ **ETHERNET SLOT**

**Caution**

- This is an ETHERNET SLOT (③): do not insert a video card (SMV-25632).
- When inserting a video card (SMV-25632), pay attention to the direction and the location so as to insert it properly.
- Video card slot

\* Start from the left: insert the card so that it is facing the left, and push until it makes a "clicking sound."

No. inserted	No. of Cameras & Monitors Controlled
1	64 cameras & 2 monitors
2	64 cameras & 4 monitors
3	64 cameras & 6 monitors
⋮	⋮
16	64 cameras & 32 monitors

# System Diagram

## 1-2. Back

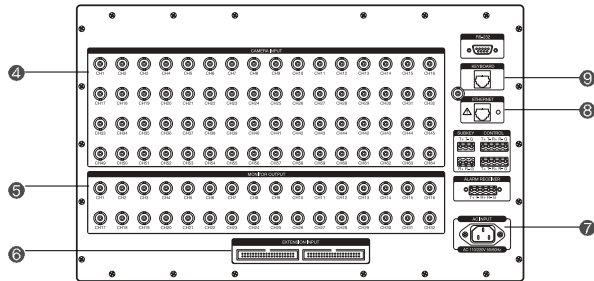

- ④ **CAMERA INPUT** : CH1 – CH64
- ⑤ **MONITOR OUTPUT**: CH1 – CH32
- ⑥ **EXTENSION INPUT** : Connect the extension unit (SME-25632)
- ⑦ **AC INPUT**  
Select a power voltage (100~120V, 210~230V)
- ⑧ **ETHERNET**  
Connect to a computer (control through a network) : To be applied in the future.
- ⑨ **KEYBOARD**  
System controller (SCC-3100) connection control

### Caution

- Use the connector included with the unit when connecting an extension unit (SME-25632) to the main CPU.

## 2. Basic Connection Diagram

### 2-1. Matrix System

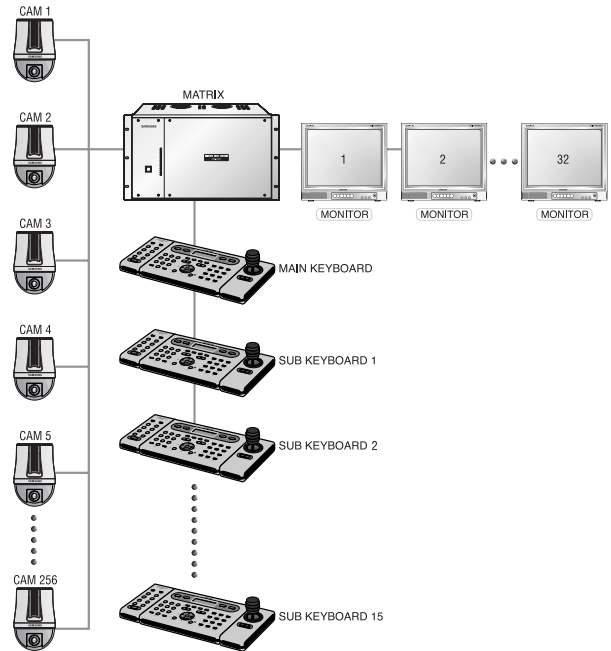

# System Diagram

## 2-2. Matrix Cable

Connection cables are within the matrix; cables may vary slightly.

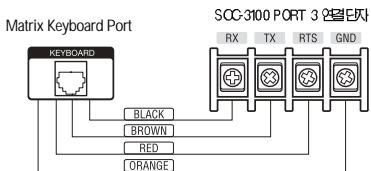

## 2-3. MATRIX Extension Unit

Diagram of Matrix main CPU(SMX-25632) & its extension units(SME-25632) proper connection.

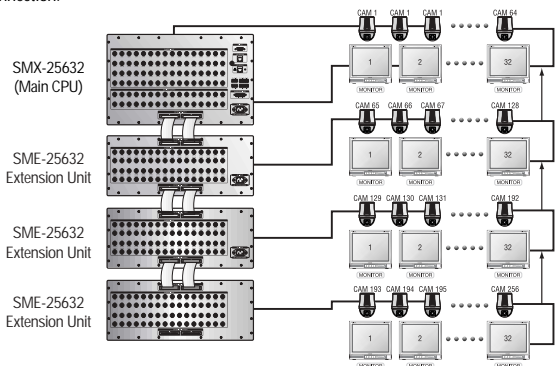

- A twisted pair cable must be used for RS -422 or RS -485 data transmission operation.
- Place extension units(SME-25632) under the Matrix Main CPU(SMX-25632).

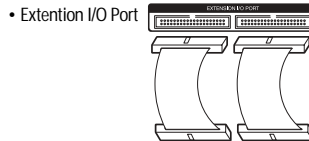

- When using a matrix extension unit (SME-25632), set the inner DIP switch.

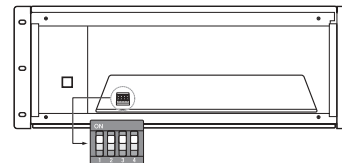

- ▶ When the Address is set to 1(ON) —sets camera no.65 to 128
- ▶ When the Address is set to 2(ON) —sets camera no.129 to 192
- ▶ When the Address is set to 3(ON) —sets camera no.193 to 256
- \* To turn address number 3 on, turn both numbers 1 and 2 on at the same time.

## 2-4. Setting the SMX-25632 DIP Switch

- The default DIP switch setting is the appropriate setting for the country the SMX-25632 is sold in.
- See below chart for the OSD and NTSC/PAL mode settings.
- Remove the front cover before setting the switches.

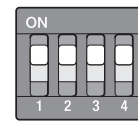

SMX-25632(dip switch)

DIP No.	ON	OFF	Detail
1	-	-	-
2	OSD, Korean	OSD, English	Select OSD
3	NTSC	PAL	Select Imaging Mode
4	-	-	-

# Matrix Settings

- Connect the system controller(SCC-3100) before setting the matrix.

## 1. Selection of Camera and Monitor

- This is a manual function to display the cameras connected to the MATRIX SYSTEM on the monitor.

Select Monitor : Select a monitor number between 1 and 32. Press ENTER.

Select Camera : Select a camera number between 1 and 255. Press CAMERA.

- Monitor must be selected before the camera. Default is 1, and up to 255 cameras can be selected by connecting up to 3 input MATRIX extensions.

## 2. Joystick for Basic Camera Controls

JOYSTICK : Used for moving the PAN/TILT up/down/left/right/diagonal.

ZOOM : Use the TELE button for Telephoto view

(Turn the TELE button or the Joystick clockwise for Telephoto view)

Use the WIDE button for WIDE view

(turn the WIDE button or the Joystick counterclockwise for WIDE view)

FOCUS : + button to focus away

- button to focus closer

## 3. AUTO SELECT

### 3-1. AUTO SELECT Setup

- This is a function to select cameras to be displayed on the monitor in AUTO RUN.

① From the initial screen, press the MONITOR button and then press the MENU button to display the [MATRIX CONTROL] menu.

```
MATRIX CONTROL
1:AUTOSELECT 2:CLEAR
3:ID SET     4:TIME SET
Press Numeric Key
```

② Press button 1 to display the [AUTO SELECT SET] menu. (In MATRIX, wait for data loading completion.)  
Select a number between 1 and 32, and then press the ENTER button to select the corresponding monitor.

```
AUTO SELECT SET
MONITOR:1 [---]
Enter: Monitor select
```

③ Select a number between 1 and 255, and then press the CAMERA button to select the corresponding camera.

```
AUTO SELECT SET
CAM ID:1
MONITOR:12 [---]
Camera: Camera select
```

④ Select a number between 1 and 60, and then press the ENTER button to select the corresponding HOLD TIME.

```
AUTO SELECT SET
CAM ID:12 Time: --- [---]
MONITOR:12 [---]
Enter: Hold time set
```

### 3-2 Cancel AUTO SELECT

- This is a function to cancel AUTO RUN

① Press the MENU button, and then press the 1 button. (In MATRIX, wait for data loading completion.)  
Press the ESC or the SET button to exit the corresponding setting.

```
MATRIX CONTROL
CAM ID:12 DRX
MONITOR:12 [---]
MASTER ID:1
```

### 3-3. Delete AUTO SELECT

- This is a function to delete each AUTO RUN setting.

① Press the MENU button, and then press button 2. Select a number between 1 and 32, and then press the ENTER button to select the monitor to be canceled.

```
AUTO SELECT CLEAR
MONITOR:12 [---]
Enter: All clear
```

### 3-4. AUTO SELECT RUN/HOLD

- Press the AUX2 button to RUN all MATRIX channels.
- Press the AUX3 button to HOLD all MATRIX channels.
- Select a number between 1 and 32, and then press the AUX2 button to RUN the corresponding MATRIX channel.
- Select a number between 1 and 32, and then press the AUX3 button to HOLD the corresponding MATRIX channel.

# Matrix Settings

## 4. ID SET

- This is a function to enter text on the corresponding camera.



### 4-1 Select ID SET

- ① From the initial screen, press the MONITOR button, and then press the MENU button to display the [MATRIX CONTROL] menu.
- ② Press button 3 to display the [CAMERA ID SET] menu. (In MATRIX, wait for data loading completion.)  
Move the joystick to select the ID CHANGE SET from the MATRIX screen, and then press the "FOCUS +" button.
- ③ Move the joystick up/down to change letters or numbers, use the joystick's ZOOM to change letters/numbers/vowels/consonants.
- ④ Press the "FOCUS +" button to save.



### 4-2. Setting ID SET ON/OFF

- ① From the initial screen, press the MONITOR button, and then press the MENU button to display the [MATRIX CONTROL] menu.
- ② Press the 3 button to display the [CAMERA ID SET] menu. (In MATRIX, wait for data loading completion.)  
Move the joystick to select the DISPLAY POSITION from the MATRIX screen, and then press the "FOCUS +" button.
- ③ Move the joystick up/down to select a monitor, move it left/right to select ON/OFF.
- ④ Press the "FOCUS +" button to save.



### 4-3. Setting the DISPLAY POSITION

- ① From the initial screen, press the MONITOR button, and then press the MENU button to display the [MATRIX CONTROL] menu.
- ② Press the 3 button to display the [CAMERA ID SET] menu. (In MATRIX, wait for data loading completion.)  
Move the joystick to select the DISPLAY POSITION from the MATRIX screen, and then press the "FOCUS +" button.
- ③ Move the joystick up/down/left/right to move the ID location.
- ④ Press the "FOCUS +" button to save.



## 5. TIME/DATE SET

- This is a function to modify the TIME and DATE on the corresponding camera.



### 5-1. Setting TIME/DATE

- ① From the initial screen, press the MONITOR button, and then press the MENU button to display the [MATRIX CONTROL] menu.
- ② Press the 4 button to display the [TIME SET] menu. (In MATRIX, wait for data loading completion.)  
Move the joystick to select the TIME/DATE SET from the MATRIX screen, and then press the "FOCUS +" button.
- ③ Move the joystick up/down to change the TIME or DATE, move it left/right to move the location.
- ④ Move the joystick to select the "SAVE?" and wait for it to blink, and then press the "FOCUS +" button to save.



## 5-2. Setting ON/OFF

- ① From the initial screen, press the MONITOR button, and then press the MENU button to display the [MATRIX CONTROL] menu.
- ② Press the 4 button to display the [TIME SET] menu. (In MATRIX, wait for data loading completion.)  
Move the joystick to select the TIME/DATE ON/OFF from the MATRIX screen, and then press the "FOCUS +" button.
- ③ Move the joystick up/down to select a monitor, move it left/right to select ON/OFF.
- ④ Press the "FOCUS +" button to save.



## 5-3. Setting DISPLAY POSITION

- ① From the initial screen, press the MONITOR button, and then press the MENU button to display the [MATRIX CONTROL] menu.
- ② Press the 4 button to display the [TIME SET] menu. (In MATRIX, wait for data loading completion.)  
Move the joystick to select the DISPLAY POSITION from the MATRIX screen, and then press the "FOCUS +" button.
- ③ Move the joystick up/down/left/right to move the display position.
- ④ Press the "FOCUS +" button to save.

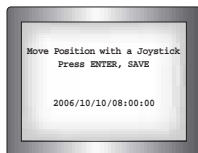

### Caution

- ERROR may occur if operated before data is fully loaded.

Symptom	Check if....	Perform
No power.	Is power supply normal?	Reconnect after checking the power supply.
Power is on but nothing is happening.	Is keyboard connection normal?	Check the keyboard connection.
Cameras are not displayed in order on the monitor.	Do camera inputs on the back match the actual camera numbers?	Check the camera inputs on the back against the actual camera numbers.
Cameras cannot be displayed on a certain monitor.	Is Video card (SMV-25632) inserted properly into the corresponding slot?	Check if the video card is inserted; with a little force, push the video card once more.
	Is connector securely connected to the monitor in question?	Check the connector connection; check the power on VCR/monitor.
One of the connected cameras cannot be displayed.	None of the monitors display the camera in question?	Check the connection between the camera in question and the main CPU; check the power on the camera.
	Only certain monitors do not display the camera?	Carefully reinsert the video card into the corresponding monitor.
Pan/Tilt functions are not working.	Is data line connected properly? (+, -)	Check the polarity and the connection of the data line.
	Do camera numbers in the controller match the R/X numbers?	Reassign the R/X or the controller numbers.

\* You must turn the power off when inserting/removing a card into/from this device.

## External View

### SMX-25632

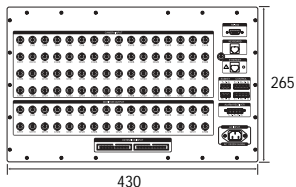
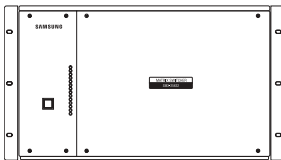
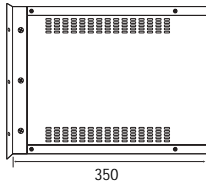

### SMV-25632

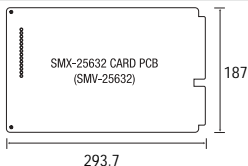

### SME-25632

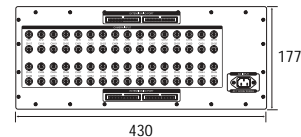
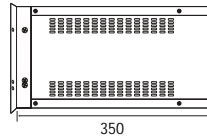

## MATRIX Features

ITEM	MATRIX Main CPU (SMX-25632)
System	16 video card slots controller interface
Features	256 x 32 video matrix control video extension unit connector (up to 3 sets) shake prevention when switching screens
OSD	displays 16 Korean characters or 32 alphabet letters, numbers, or symbols date/time display
Camera I/O	64 camera input, 32 monitor output
Communication	TTL LEVEL
Operating Environment	0°C ~ +40°C (32°F ~ 104°F)
Weight	Approx. 15kg (approx. 33lb)
Size	430(W) x 265(H) x 350(D)mm (approx. 17x10x14in)

ITEM	Video MATRIX extension unit (SME-25632)
Features	64 camera input control
Camera I/O	64 input channels, 32 extension output channels
Power Wattage	50 watts
Operating Temperature	0°C ~ +40°C (32°F ~ 104°F)
Weight	Approx. 10Kg (approx. 22lb)
Size	430(W)x177(H)x350(D)mm

ITEM	Video Card (SMV-25632)
Features	time generator I/D generator video I/O selector video sync correction
OSD	32 alphabet letters or 16 Korean characters (combinations allowed) freeze On/Off year, month, date, hour, minute, second
Camera I/O	64 input, 2 monitor output
Power Wattage	max. 9 watts
Operating Temperature	0°C ~ +40°C (32°F ~ 104°F)
Weight	Approx. 0.3Kg (approx. 10oz)

\* Standards may change without prior notice in order to improve performance/quality of the product.

MEMO

MEMO

MEMO