

SAMSUNG

*Overcoming a Limitation  
of the Dark*

1/2" High Resolution Ultra Low Light Camera

*SHC-740*



There are those who work hard for your safety even while you are asleep...

*SHC-740*, the ultimate low-light level security.





Some work hard to keep places safe even while the world is asleep. **SAMSUNG TECHWIN** helps day and night the military who guard the country and its people all over the world, in order to establish 'The intelligent security and surveillance system for the military area'. With 30 years of experience and technology in the safeguard/security industry, **SAMSUNG TECHWIN** introduces the **SHC-740** low-light level surveillance camera, which is designed to provide the unmatched high quality and performance in security.

**SHC-740** is a product of an optimum combination of **1/2" Ex-view HAD CCD** and **Samsung SVIII DSP chip** that opened a new chapter in the low-light level technology, and its high resolution image surveillance function enables the user to identify objects clearly even in the dark. It provides the best quality and performance in those areas which require a high degree of night-time surveillance such as airports, harbors, roads, large scale industrial sites and military establishments, e.g, a truce line.

**SHC-740, the authentic low-light level camera that safeguards areas even in the dark**

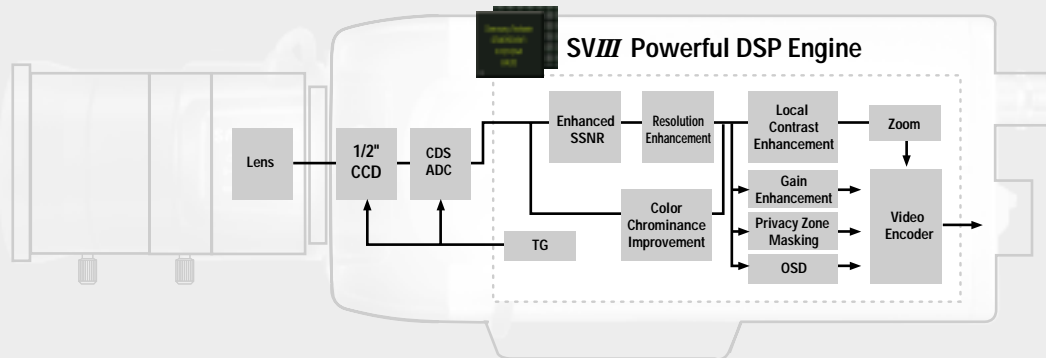

Uses 1/2" Ex-view HAD CCD!



Unique noise reduction & disk saving, SSNR!



Super low-light image of SVIII DSP!



Great resolution of 530TVL Line!

# SHC-740, the ultimate low-light level security - the best choice



LOW LIGHT\_SSNR

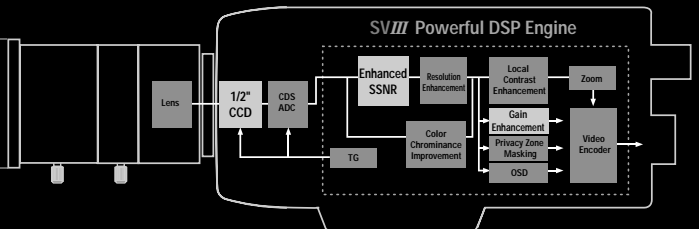

LOW LIGHT



Excellent color super lowlight

surveillance of **0.08Lux**

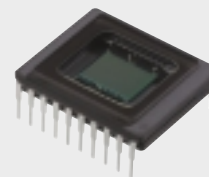

The new SHC-740 has a built-in 1/2" Ex-view HAD CCD and also employs the Samsung **SV888** DSP chip resulting in a super low-light level of 0.08Lux in normal color mode and 0.0006Lux@F1.2 in Sens-up mode. Therefore, objects can be clearly identified even in darkness.

SSNR



Clear image without noise,

**70%** DVR capacity reduction



**SV888** chip employs SSNR to provide a clear image by blocking video noise and preventing dragging and stretching of image which is normally hard to avoid in low-light level surveillance. This makes easier the identification of vehicle registration number and objects and also reduces up to **70%** the DVR capacity.

Complete blocking of low-light level noise



Great reduction in DVR recording capacity

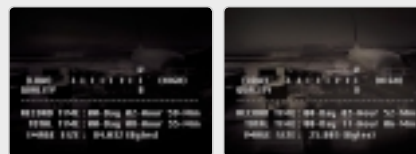

84.032 Bytes

100%

Conventional camera

25.803 Bytes

30%

SHC-740

*SHC-740*, the ultimate low-light level security - the best choice



RESOLUTION

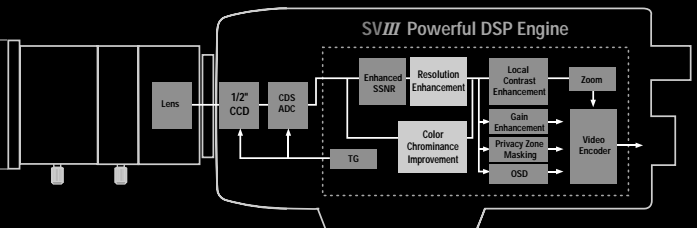

# RESOLUTION



## Superb high resolution of 530TV Lines

By combining Samsung's experience in advanced optical technology, 1/2" Ex-view HAD CCD and **SVIII** DSP chip, horizontal resolution has been achieved higher than **530TV lines** resulting in clearer image quality and more accurate color presentation compared to performance of present surveillance cameras. Its S/N ratio is over 50dB, which also contributes to clearer image quality.



Conventional camera

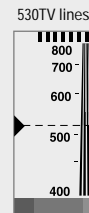

SHC-740



## Wide Range **White Balance** Function

It offers a unique white balance function which automatically selects the optimum color within the color temperature range of 1,800°K ~ 10,500°K resulting in an accurate color presentation whether it is outdoor, outside in the front entrance or inside a tunnel that is lit with a sodium vapor lamp.



*SHC-740*, the ultimate low-light level security - the best choice



MULTI FUNCTION

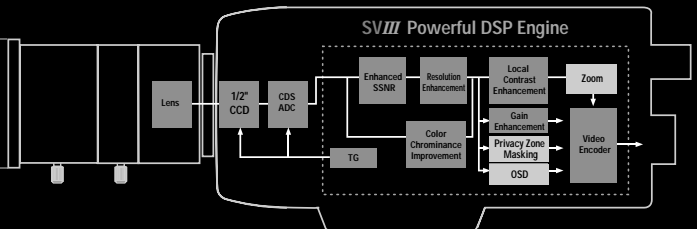

# FUNCTION



## Day & Night function with ICR

IR Cut Filter method is used when you wish to automatically detect Day & Night conditions and change modes for an optimum surveillance.



Day



Night



## MD (Motion Detection)

A single screen can be subdivided into 48 zones; therefore, any problematic zone can be identified and checked immediately. Efficient and intensive surveillance on a single area as well as on multiple areas can be carried out easily.



Motion Detected



## Privacy masking in specific zones

If there is a question of privacy invasion within the surveyed area, the privacy masking function can be set to mask up to 4 zones in a single screen.

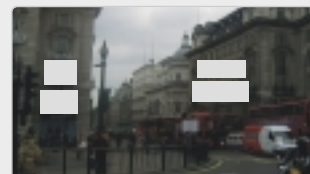

## OSD (On Screen Display)

SHC-740 has an on screen text display menu for easier selection and control of functions. Users can use the camera identification (camera ID) to assign name to the camera.



OSD functions

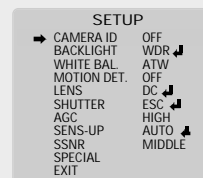

## 8X Digital zoom

Powerfully built maximum 8X digital zoom function helps identify an object more accurately.



*SHC-740*, the ultimate low-light level security - the best choice





1/2" High Resolution Ultra Low Light Camera  
*SHC-740N*

***Samsung's thorough quality test,  
strong durability for outdoor use***

In order to ensure that the products achieve the highest possible performance in any circumstance, we, **SAMSUNG TECHWIN**, do our best to carry out many quality tests such as an electrical reliability test including static electricity, impulse noise, power fluctuation range, temperature range guarantee test in different environments, impact test, vibration test for transporting products and day & night durability test. All the limit values for the tests have been maximized specifically so that **SHC-740** can withstand extreme outdoor conditions and achieve the best image in those conditions. As a result, we have achieved trustworthy quality in our products.



Electrical reliability test



impulse noise test



Temperature range guarantee test



Vibration test



Transporting products test



Day & Night durability test

## Specifications

Model	SHC-740N	SHC-740P
Power Source	24V AC / 12V DC ( $\pm 10\%$ )	
Power Consumption	Max. 4.5W	
Imaging Device	1/2" Ex-view HAD CCD	
Total Pixels	811(H) x 508(V)	795(H) x 596(V)
Effective Pixels	768(H) x 494(V)	752(H) x 582(V)
Scanning System	2 : 1 Interlace	
Synchronization System	Internal / Line lock	
Scanning Frequency	Horizontal : 15.734KHz Vertical : 59.94Hz	Horizontal : 15.625KHz Vertical : 50.00Hz
Resolution	530TV Lines(Min.) : Color / 570TV Lines(Min.) : B/W	
Video Output	1.0Vp-p / 75 $\Omega$ (Video : 0.714Vp-p, Sync : 0.286Vp-p)	1.0Vp-p / 75 $\Omega$ (Video : 0.7Vp-p, Sync : 0.3Vp-p)
S/N (Y signal)	50dB (AGC off, Weight on)	
Min. Illumination	Color : 0.08Lux, F1.2 (50 IRE) / B/W : 0.01Lux, F1.2 (50 IRE)	
WDR	42dB	
Day & Night	Color / BW / Auto (ICR Filter change) / EXT (External Day & Night mode control capability via terminal on the back panel)	
Gain Control	Low, High, Turbo, Off selectable	
White Balance	ATW / AWC / Manual (1800°K ~ 10,500°K)	
Electronic Shutter	Auto / Manual (1/60 ~ 1/100,000sec)	Auto / Manual (1/50 ~ 1/100,000sec)
Sens-up	On / Off (Selectable limit ~ 128X)	
OSD	Built-in	
Motion Detection	On / Off (Built-in alarm output connector)	
RS-232C	Built-in	
SSNR	Low, Middle, High, Off selectable	
Digital Zoom	Built-in (~8X, Pan Tilt)	
Privacy Function	On / Off (4 Programmable zone)	
IRIS Control	DC / Video	
Lens Mount	CS Mount (Easy focus type) (C-Mount is mountable by using adaptor)	
Operating Temperature	-10°C ~ +50°C	
Operating Humidity	Max. 90% RH	
Dimension	69(W) x 56(H) x 125(D)mm	
Weight	480g	

## Dimensions

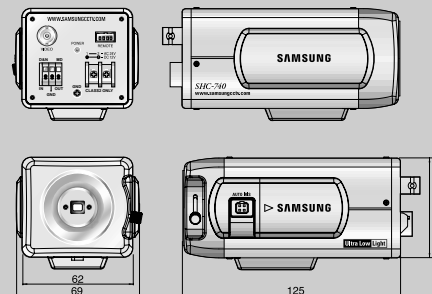

## Rear Panel

